

User Guide

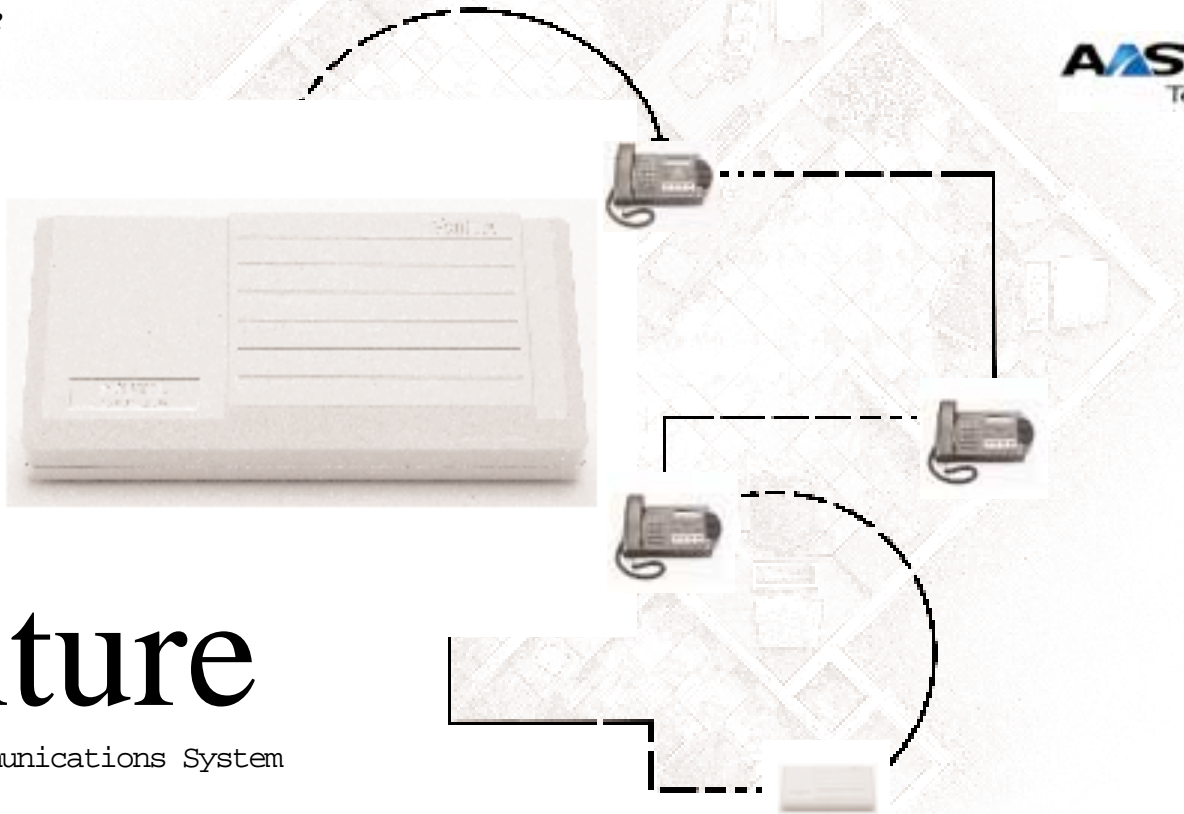

Venture

Multiline Communications System

Introduction 1

Unpacking the EFA 2

EFA ports 3

Connecting your EFA to your Venture System ... 4
 Verify that the EFA is connected to your system..... 5

Adding a music source 5
 Connecting a music source..... 5
 Activating Music on hold..... 5
 Activating Background music 6

Adding loudspeaker paging 6
 Connecting a loudspeaker page amplifier 6
 Activating loudspeaker paging..... 6

Adding the Venture Door Phone 6
 Connecting your Venture Door Phone 7
 Activating your Venture Door Phone..... 7
 Setting Door phone options..... 7

Adding an electronic door latch 8
 Connecting your electronic door latch 8

Adding a fax machine or modem 8
 Connecting your fax machine or modem to your EFA.....9
 Activating Fax switch9

Adding a Call Detail Recording 9
 Connecting a computer9
 Connecting a printer.....10
 Activating CDR10

Adding account code capabilities to CDR 11

Password protecting the EFA option settings .. 11

Using EFA functions 11
 Answering a door phone call11
 Turning Background music ON or OFF at each Venture phone
 12
 Using an account code while on a call.....12
 Loudspeaker paging13
 Saving Background music and Account code to a Memory key
 13
 Saving Door phone to a Memory key13

Troubleshooting 14
 EFA options does not appear in the Services list14

You forgot your password..... 14

Appendix..... 15

 Running cable to the jacks 15

 Terminating two lines on the EFA 16

 EFA connection requirements 17

Canadian regulatory information 19

U.S. regulatory information..... 20

Index 25

Contents

Introduction

Congratulations! Adding the Enhanced Feature Adapter (EFA) to your Venture system enables you to connect seven devices: a music source, an external page amplifier, a door phone, a door locking/unlocking device, a fax machine or modem, and a printer or a PC.

Adding these devices to your Venture system enables you to:

- provide music to callers who have been put on hold
- play music though the handsfree speaker of your phone
- page over a public address system
- answer and open a door from a phone in your Venture system
- use one line alternately for voice calls, and for faxes or modem transmissions

- accumulate and display Call Detail Recording (CDR) accounting information

This User guide explains how to install the EFA, and to program and use the EFA options.

 **Note:** Any wiring of your home or office that may be required to install the devices connected to your EFA should be done by following the instructions that come with each device. These instructions are not covered in this *EFA User Guide*.

Unpacking the EFA

When you unpack the EFA you should have: one EFA, one telephone cord and one AC power adapter.

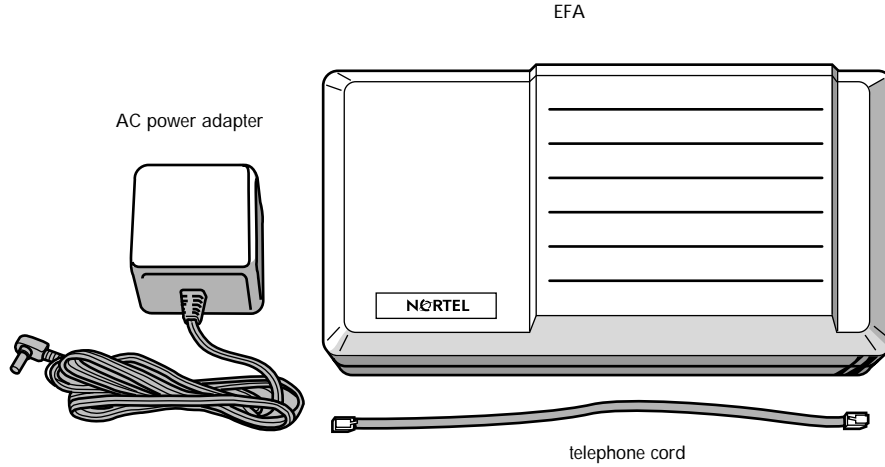

EFA ports

There are eight ports on the EFA:

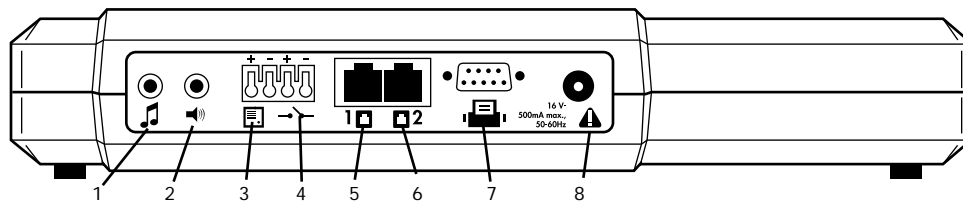



Each port connects a different device to your Venture system:

1. a music source
2. an external paging amplifier
3. a door phone
4. a door locking/unlocking device
5. the phone line used as line 1 on your Venture phone or system, and if a fax or modem is attached, a second phone line to be used for the fax
6. a fax machine or modem
7. a serial printer or a PC used as a Call Detail Recording output device
8. the AC power adapter provided with your EFA

Connecting your EFA to your Venture System

1. Plug one end of the 6-wire cord provided with your EFA into a phone jack on which the telephone line, used as line 1 on your Venture system, is terminated.

 **Note:** If the EFA will be used with a fax machine or modem, a second line to be used for the fax or modem line must also be terminated on this jack. See “Terminating two lines on the EFA” on page 16.

2. Plug the other end of the 6-wire cord into the telephone  port on your EFA.
3. Plug the power adapter cord into the AC power  port on your EFA.
4. Plug the power adapter into an AC outlet.

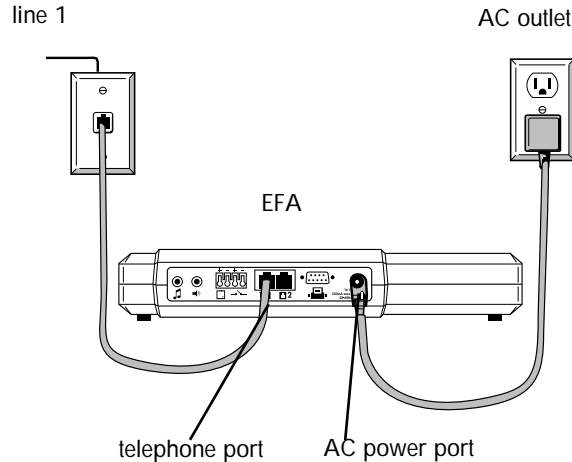

Verifying that the EFA is connected to your system

1. Go to any Venture phone.
2. Press **Services**.
3. Press  until your display shows **EFA options**. If your display does not show EFA options, see “Troubleshooting” on page 14.

Adding a music source

Adding a music source to your EFA enables you to:

- provide music to calls on hold for every telephone line connected to your Venture system
- play background music through the handsfree speaker on idle phones

 **Note:** Depending on your music source, applicable copyright law may require that a

license be obtained for the right to reproduce or transmit the music source through the music on hold or background music features of this telecommunications system. Venture purchasers are solely responsible for obtaining any such license(s); in no event will Northern Telecom or any of its subsidiaries be liable for a failure to obtain the required licenses.

Connecting a music source

You will need a cable with a 3.5 mm earphone jack on one end and whatever is required to fit the output of your music source on the other end. Three typical types of connectors are:



- for tape or CD players and tuners — an RCA jack
- for amplifiers — a 3.5 mm earphone jack



1. Plug the cable into the output (line out) of your music source.

 **Note:** Do *not* plug the cable into the loudspeaker output of your music source. If your music source has a separate amplifier, use the auxiliary, line out or headphone output jacks. ***This could damage both your EFA and the music source.***

2. Plug the other end of the cable into the  port on your EFA.
3. Turn on the music source.





Activating Music on hold

1. Go to any Venture phone.
2. Press **Services**.
3. Press  until your display shows **EFA options**.
4. Press .

5. Press  until your display shows **Music on hold**.
6. Press  to turn on Music on hold.

Activating Background music

Activating background music at any Venture phone makes music available to all Venture phones on the system. Background music is then turned ON or OFF at each phone.

1. Go to any Venture phone.
2. Press .
3. Press  until your display shows **EFA options**.
4. Press .
5. Press  until your display shows **Music at idle**.
6. Press  to turn on background music.



Note: See also, “Turning Background music ON or OFF at each Venture phone” on page 12.

Adding loudspeaker paging





Connecting a loudspeaker paging amplifier for a public address system enables you to make loudspeaker announcements from your Venture phones. With loudspeaker paging activated, when you page all phones from any Venture phone, your message will be sent out over the public address system as well as to all of your Venture phones.

Connecting a loudspeaker page amplifier

You will need a cable with a 3.5 mm earphone jack on one end and whatever is required to fit the input of your external page amplifier on the other end. These are available at most electronics and audio stores.

1. Plug one end of the cable into the input port of your paging amplifier as shown in the amplifier instructions.
2. Plug the other end of the cable into the  port on your EFA.
3. Turn on your external page amplifier and follow the manufacturer’s instructions for selecting the appropriate input.

Activating loudspeaker paging

1. Go to any Venture phone.
2. Press .
3. Press  until your display shows **EFA options**.
4. Press .
5. Press  until your display shows **Extern Page**.
6. Press  to turn on external paging.

Adding the Venture Door Phone

Adding the Venture Door Phone (Aastra part number: A0665958) enables you to answer a door from one or all the phones in your Venture system.

 **Note:** Only the Venture Door Phone can be used with your EFA.

Connecting your Venture Door Phone



You will need a pair of 16 to 20 gauge solid wires such as telephone wire or doorbell wire. These are available at most hardware and building supply stores.



1. Follow the instructions included in your Venture Door phone for connecting the wires to it.
2. Strip approximately 1/4 inch of insulation from the other end of the wires.

3. If the wires are stranded, apply solder to the wires to make them solid enough to insert into the EFA terminals.
4. Insert the wires into the two  terminals. It does not matter which wire goes into which terminal.

 **Note:** To disconnect the door phone wires from the EFA, insert a stiff piece of wire (such as a paper clip) into the slot above the wire while pulling the wire out of the terminal.

Activating your Venture Door Phone

1. Go to any Venture phone.
2. Press .
3. Press  until your display shows **EFA options**.
4. Press .

5. Press  until your display shows **Door Phone**.
6. Press  to turn on door phone answering capabilities.

Setting Door phone options

By setting the following options, you can customize the way your door phone works.

Door Phone name—changes the door phone name to any 16-character name you choose.

Door Phone ID—changes 98, the ID assigned to your door phone at the factory, to any 2-digit number you choose.

Door timeout—sets the number of times a phone will ring when the door phone button is pressed. (The default is three rings.)



Door calls all/Door calls Phone—sets door phone calls to ring at all phones or one phone in your

system. (Door calls all is the default setting.)

 **Note:** When Door calls

Phone is selected, but the call is not answered by the selected phone (after the programmed number of rings), the door phone call will ring on all Venture phones.

Phone ID to call—when you select Door calls Phone, Phone ID to call selects one phone to which all door phone calls will go.

1. Go to any Venture phone.
2. Press **Services**.
3. Press  until your display shows EFA options.
4. Press .
5. Press  until your display shows the Door phone option you want to set.
6. Press \yen .

7. Follow the display prompts.

Adding an electronic door latch

When you have added the Venture Door Phone to your system, you can use an electronic door latch to release the door lock from your Venture phones.

Connecting your electronic door latch

You will need a pair of 16 to 20 gauge solid wires such as telephone wire or doorbell wire available at most hardware or building supply stores.

1. Follow the door latch manufacturer's instructions to connect one end of the wires in place of the push button actuator of the doorlatch.
2. Strip approximately 1/4 inch of insulation from the other end of the wires.

3. If the wires are stranded, apply solder to the wires to make them solid enough to insert into the EFA terminals.
4. Insert the wires into the two  terminals on the EFA. It does not matter which wire goes into which terminal.

 **Note:** To disconnect the door latch wires from the EFA, insert a stiff piece of wire (such as a paper clip) into the slot above the wire while pulling the wire out of the terminal.

Adding a fax machine or modem

If you subscribe to the telephone service provider feature called Distinctive Ringing, adding a fax machine or modem to your system through your EFA will enable you to use one line alternatively for making (and receiving) phone calls and for sending (and receiving) faxes or

modem transmissions. The line used for both the fax or modem calls and phone calls must be wired as line 2 in the phone jack that you plug your EFA into.

 **Note:** On line 2 the distinctive ring phone number must be assigned to the fax machine or modem.

 **Note:** Distinctive Ringing may also be called Ident-a-call, Ident-a-ring, Teen Service, Smart Ring, Signal Ring or Custom Ringing.





Connecting your fax machine or modem to your EFA

1. Plug one end of the phone wire that comes with your fax or modem into your fax or modem.
2. Plug the other end of the phone wire into the second  port on your EFA.

3. Set your fax machine or modem to answer after 3 or more rings.

Activating Fax switch

This activates the Fax switch feature.

1. Go to any Venture phone.
2. Press .
3. Press  until your display shows **EFA options**.
4. Press .
5. Press  until your display shows **Fax switch**.
6. Press  to turn Fax switch on.

 **Note:** The distinctive ring line assigned to the Fax switch rings at all Venture phones.

Adding a Call Detail Recording

Connecting a printer or computer with Call Detail Recording (CDR) software to your system through your

EFA, provides accounting information on all incoming and outgoing calls except for calls less than five seconds long, unanswered calls and intercom calls. You can also to enter an up to 4- digit account code during a call so that you can track calls for a specific customer or account.

Your EFA requires:

- a serial printer set at 9600 baud with a minimum of 40 columns.
- OR**
- a computer with Call Detail Accounting software package that accepts SL-1 records.

 **Note:** Your CDR printer will record all numbers dialed including passwords. *Ensure that the printer or computer is located where this information can remain confidential.*

Connecting a computer

You will need a 9-pin serial cable. In addition, if your computer uses a 25-pin connector for its serial port, you need a 9-pin to 25-pin adapter. These are available at any computer store.

1. Plug one end of the serial cable into your computer.
2. Plug the other end of the serial cable into your  port on your EFA.
3. Follow the instructions that came with your software to configure your computer for the following serial format:
 - 9600 baud
 - 8 data bits
 - No parity
 - 1 stop bit

Connecting a printer

To connect a printer, you will need a 9-pin null modem adapter and a 9-pin serial cable. In addition, if your printer uses a 25-pin connector for its serial port, you will also require a 9-pin to 25-pin adapter. These are available at any computer store.

 **Note:** The Scriptos

Technologies serial printer. No. 550 0102 02 103 is an example of a serial printer that works with the Venture EFA.

1. Plug the null modem adapter into either end of your 9-pin cable.
2. Plug either end of the 9-pin cable into your printer.
3. Plug the other end of the 9-pin cable into your  port on your EFA.

4. Follow the instructions that came with your printer to configure your printer for the following serial format:

- 9600 baud
- 8 data bits
- No parity
- 1 stop bit

Activating CDR

Activating CDR includes turning on CDR, turning on Account code and selecting on of these four CDR output formats:

- **CDR in English**—a printer format used to print call records in English
- **CDR in French**—a printer format used to print call records in French
- **CDR in Spanish**—a printer format used to print call records in Spanish

- **CDR as SL-1 data**—a computer format used by call detail accounting software

1. Go to any Venture phone.
2. Press **Services**.
3. Press **▼** until your display shows **EFA options**.
4. Press **●**.
5. Press **▼** until your display shows **CDR OFF**.
6. Press **¥** to turn CDR on.
7. Press **▼** until your display shows **Account code OFF**.
8. Press **¥** to turn Account code on.



Note: Account code ON enables you to enter a 4-digit code during a call so that you can track calls for a specific customer or account.

9. Press **▼** until your display shows **CDR in English**
▼=next *≠change.
10. If CDR in English is your preference, press **Quit** to exit the list or press **▼** to go to the next EFA option.

OR

If you want a different CDR format, press **¥** and go on to step 11.

11. Press **▼** until your display shows the format you want.
12. Press **¥**. Your display shows the option you selected and **- confirmed -**.

Password protecting the EFA option settings

When a 4-digit password is used, you can limit access to the EFA options sublist in the Services list to those who know the password.

1. Go to any Venture phone.
2. Press **Services**.
3. Press **▼** until your display shows **EFA options**.
4. Press **●**.
5. Press **▼** until your display shows **Password**.
6. Press **¥**.
7. Follow the prompts to enter the 4-digit password.

Using EFA functions

The following EFA functions are activated at each Venture phone:

- answering door phone calls
- turning background music on and off
- adding account code information for individual phone calls to CDR records
- paging

Answering a door phone call





When you have activated the door phone option on your Venture phone and the door phone rings, your display shows **Door Phone calling**.

 **Note:** If you are using your intercom line, when a door phone call is received, you must release your ongoing intercom call to answer the incoming door phone call.

 **Note:** When **Door calls Phone** is selected, but the call is not answered by the selected phone (after the programmed number of rings), the door phone call will ring on all of your Venture phones.

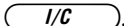
 **Note:** If all the intercom paths are busy when a door phone call comes in, your display shows the **Door Phone, 98** (or any other 2-digit ID you have assigned to the door

phone). To answer the door, go to the door.

1. Pick up the handset or press handsfree/mute key.
2. Press .
3. Press  until your display shows **Door Phone**.
4. Press .
5. Speak to the person at the door.
6. If you have a door unlocking device and want to open the door, press  to open the door.

Turning Background music ON or OFF at each Venture phone

1. Press .
2. Press  until your display shows **Background music**.

 **Note:** Background music must be activated for this message to be displayed.

3. Press  turn Background music on.

OR

1. If you have saved Background music to a memory key, press the memory key twice.

 **Note:** See “Saving Background music and Account code to a Memory key” on page 13.

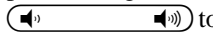

 **Note:** You can adjust the volume of music through the speaker when it is playing:

- press the right end of the  to increase the volume.

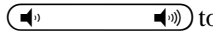
OR

- press the left end of the  to decrease the volume.

Using an account code while on a call

1. Make or answer a call.
2. Press **Services**.
3. Press  until your display shows **Account code**.
4. Press .
5. Enter a 1 to 4-digit account code.

OR

 **Note:** When more than one phone is included in a call, the account code record lists only the phone that made or answered the call.

 **Note:** When an account code is entered during a conference call, it overrides any previously entered account code.

1. If you have saved account code to a memory key, make or answer a call.

2. Press the memory key.
3. Press .
4. Enter a 1 to 4-digit account code.



 **Note:** See “Saving Background music and Account code to a Memory key” on page 13.

Loudspeaker paging

When the **Extern Page** option is set to ON, when you page all phones on your Venture system, your page is also broadcast over your public address system.

Saving Background music and Account code to a Memory key

Background music and Account code EFA options are stored in the Services list as services once they have been programmed. From the Services list they can be saved to a memory key.

1. Press **Services**.
2. Press  or , until your

display shows **Background music** or **Account code** in your Services list.

3. Press **Save**. The display shows **Save to?**
4. Press the memory key that you want to use.
5. Follow the display prompts.

Saving Door phone to a Memory key

When the Door phone option is activated, the Door phone is listed in your Phone list and your Directory. From the Phone list or the Directory, it can be saved to a memory key.

1. Press  until your display shows **Door Phone**.
2. Press **Save**. Your display shows **Save to?**
3. Press the memory key that you want to use. The display shows **Saved: Memory key Door Phone**.

Troubleshooting

Troubleshooting is required when you install your EFA and EFA options does not appear in the Services list or when you forget your password.

EFA options does not appear in the Services list

1. Ensure that there are 3 spaces available in your Services list to display Background music, Account code and EFA options.



Note: The Services list has a total of 20 spaces. To free up spaces in your Services list you can delete services or save services to your memory keys.

2. Ensure that your EFA is plugged into a live AC outlet.
3. If the problem persists, unplug your EFA from the phone jack.
4. Plug in a phone.

5. Pick up the handset. You should hear dial tone.
6. Check on a Venture phone to ensure that the **Line 1** indicator light is lit.
7. If there is no dial tone, or the phone's **Line 1** indicator light is not lit, verify that the phone jack is wired correctly, see "Terminating two lines on the EFA" on page 16.
8. If line one has dial tone and the indicator light is lit, reconnect your EFA.
9. If EFA options is still not available in the Services list, open the Termination Module included with your EFA and follow the instructions included with it.
10. If problems persist call the Aastra help desk at 1-800-574-1611.

You forgot your password

You can't enter the EFA options list because you have forgotten the password.

1. Press **Services**.
2. Press until your display shows EFA options.
3. Press . The display reads **Please enter Password >**.
4. Enter the month, date and hour (in 24 hour format) displayed on the phone.

If your phone is displaying **FEB 21 3:45PM**, the password would be 022115.

5. Press repeatedly until your display shows **password**.
6. Press . The display shows your 4-digit password.

Appendix

This appendix provides in-depth information required to complete the wiring of a Venture EFA, from the connecting blocks to a Venture EFA. It is intended for use by installers or individuals with system wiring experience.

Running cable to the jacks

When wiring is required for new installations or to provide additional phone lines:

- A separate jack is required for the EFA.
- The same telephone line must appear as line 1 on each Venture phone and the EFA so that the EFA will appear in the Services list of each phone.
- Three (or more) twisted-pair cable is recommended.
- Running cable from the connecting blocks to the EFA

and the telephones (a home run configuration) is recommended.



Note: In a home run configuration a separate cable is run from the connecting block to each telephone and from the connecting block to the EFA.

Terminating two lines on the EFA



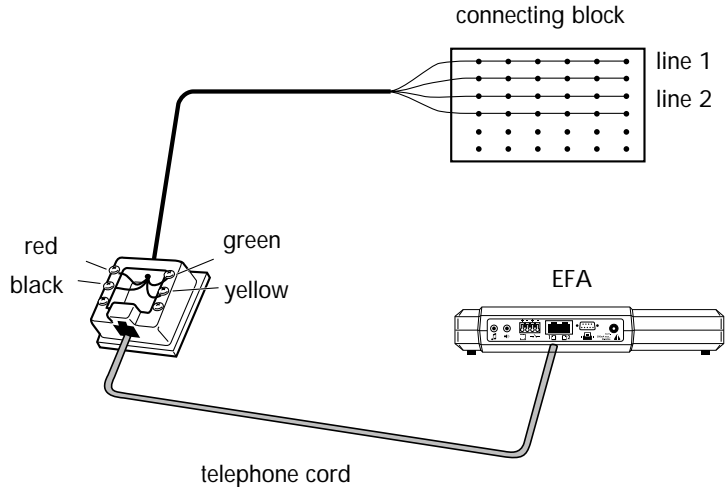

This is required when a fax machine or a modem will be sharing a telephone line with a phone in your system.





1. Connect phone line 1 to the red and green pins of the phone jack
2. Connect phone line 2 to the black and yellow pins of the first phone jack.
3. Plug one end of the telephone cord provided with the EFA into the phone jack.
4. Plug the other end of the telephone cord into the phone port on the EFA.



EFA connection requirements

The following table shows the ICON for the port to which the device should be connected, the type of connector required, the acceptable level of input and output and impedance for each device connected to the EFA.

Device	Port ICON	Type of connector required and acceptable levels of input or output and device impedance
Music source (CD player, radio etc.)		3.5 mm mini jack connector (output appears on left channel of a stereo jack only) Input level of -20dBVrms to +6dBVrms Input impedance is 5 Kohms
External page amplifier		3.5 mm mini jack connector, (output appears on both the left and right channels) Output impedance is 600 ohms. Output level is -14 dBVrms open circuit (-20 dBVrms into 600 ohms).
Venture door phone		Push-in type connector suitable for AWG 16 to AWG 20 solid or tinned stranded wire The Venture door phone is the only door phone that can be attached to the EFA. The Aastra part number for ordering a door phone is AO665958.
Door lock/unlock interface (A normally open relay contact used to control a door latch solenoid or similar device.)		Push-in type connector suitable for AWG 16 to AWG 20 solid or tinned stranded wire Rating of relay contacts; 1 Amp at 30 Vdc, 0.3 Amp at 110 Vdc, 0.5 Amp at 125 Vdc

The telephone line used as line 1 on the Venture phone(s) and a second telephone line used for the fax machine.	 1	RJ12 jack. (This cord is provided with the EFA.)
Fax machine or modem	 2	RJ12 jack. (The Venture EFA is configured so the fax or modem line appears on pins 3 and 4 of jack number 2.)
Printer or computer		DB9 connector. To connect a printer a null modem is also required. To connect a computer with a 25-pin serial port connector a 9-pin to 25-pin adapter is also required.
AC power		The AC adapter is included with your EFA. 16 Vrms, 50/60 Hz, 500 ma

Canadian regulatory information

Industry Canada Notice

The Industry Canada label identifies certified equipment. This certification means that the equipment meets certain telecommunications network protective, operational and safety requirements. The Department does not guarantee the equipment will operate to the user's satisfaction.

Before installing this equipment, users should ensure that it is permissible to be connected to the facilities of the local telecommunications company. The equipment must also be installed using an acceptable method of connection. The method of connection approved for this equipment as designated by D.O.C. Standard CS-03 is a CA11A/CA14A or CA11W/CA14W connection arrangement. The A or W suffix indicates that either desk or wall mounting is approved. In some cases, the company's inside wiring associated with a single line individual service may be extended by means of a certified jack-plug-cord ensemble (telephone extension cord). The customer should be aware that compliance with the above conditions may not prevent degradation of service in some situations.

Existing telecommunications company requirements do not permit their equipment to

be connected to customer provided jacks except where specified by individual telecommunications company tariffs.

Repairs to certified equipment should be made by an authorized Canadian maintenance facility designated by the supplier. Any repairs or alterations made by the user to this equipment, or equipment malfunctions, may give the telecommunications company cause to request the user to disconnect the equipment.

Users should ensure for their own protection that the electrical ground connections of the power utility, telephone lines and internal metallic water pipe system, if present, are connected together.

This precaution may be particularly important in rural areas.

CAUTION: Users should not attempt to make electrical ground connections themselves, but should contact the appropriate electric inspection authority, or electrician, as appropriate.

NOTICE: The Load Number (LN) assigned to each terminal device denotes the percentage of the total load to be connected to a telephone loop which is used by the device, to prevent overloading. The termination of a loop may consist of any combination of devices subject

only to the requirement that the sum of the LN of all the devices does not exceed 100.

This telephone has been tested and found to comply with the limits for a Class B digital device in accordance with the Canadian EMI requirement ICES-003.

CAUTION: To eliminate the possibility of accidental damage to cords, plugs, jacks and the telephone, do not use sharp instruments during the assembly procedures.

WARNING: Do not insert the plug at the free end of the receiver cord directly into a wall or baseboard jack. Such misuse can result in unsafe sound levels.



The exclamation point within an equilateral triangle is intended to alert the user to the presence of important operating and maintenance (servicing) instruction in the literature accompanying the product.

This symbol on the product is also used to identify the following important information:

Shock Hazard Warning:

To avoid potential electrical shock hazard to personnel or damage to the telephone, use only the manufacturer supplied equipment and installation procedures. Specifically, use only 6 conductor modular Teladapt plug/cords with

this product, and the AC transformer must be CSA/UL or CSA-NRTL/C approved Class 2, level C, rated as follows:

For North American Markets mains nominal AC voltage 110-117V:

For Venture EFA- Input: 117/120VAC, 50/60Hz, 12W and Output: 16VAC 500 mA.

For International Markets mains nominal AC voltage 220-240V:

For Venture EFA- Input: 220/240VAC, 50/60Hz, 12W and Output: 16VAC 500 mA.

Substitution of non approved equipment will void the Aastra warranty.

U.S. regulatory information

Radio/TV interference

Terminals equipped with electronic push-key dials generate and use radio frequency energy, and if not installed and used properly and in strict accordance with the manufacturer's instructions, may cause interference to radio and television reception. These terminals have been tested and found to comply with the limits for a Class B digital device in accordance with the specifications in Part 15 of the FCC rules. While these rules are

designed to provide reasonable protection, there is no guarantee that interference will not occur in a particular installation. You can determine whether interference occurs by monitoring your radio or television reception while placing a call.

If your terminal causes interference, one of the following measures may correct the problem:

Reorient or relocate the receiving TV or radio antenna, where this may be done safely.

To the extent possible, move the telephone and the radio or television farther away from each other, or connect the telephone and the radio or television to outlets on separate circuits.

Consult the dealer or an experienced radio/television technician for additional suggestions.

Federal Communications Commission (FCC) notice

FCC registration number: This telephone equipment complies with Part 68, Rules and Regulations, of the FCC for direct connection to the Public Switched Telephone Network. (The FCC registration number appears on a sticker affixed to the bottom of the telephone.)

Note: FCC registration does not constitute an expressed or implied guarantee of performance.

Your connection to the telephone line must comply with these FCC rules:

Use only an FCC standard RJ11W/RJ14W or RJ11C/RJ14C network interface jack and FCC compliant line cord and plug to connect this telephone to the telephone line. (To connect the telephone, press the small plastic tab on the plug at the end of the telephone's line cord. Insert into a wall or baseboard jack until it clicks. To disconnect, press the tab and pull out.)

If a network interface jack is not already installed in your location, you can order one from your telephone company. Order RJ11W/RJ14W for wall-mounted telephones or RJ11C/RJ14C for desk/table use. In some states, customers are permitted to install their own jacks.

Your telephone may not be connected to a party line or coin telephone line. Connection to Party Line Service is subject to state tariffs. (Contact the state public utility commission, public service commission or corporation commission for information.)

It is no longer necessary to notify the Telephone Company of your phone's Registration and REN numbers. However, you must provide this information to the telephone company if they request it.

If this terminal equipment causes harm to the telephone network, the telephone company will notify you in advance that temporary discontinuance of service may be required. If advance notice isn't practical, the telephone company will notify the customer as soon as possible. Also, you will be advised of your right to file a complaint with the FCC if you believe it necessary.

The telephone company may make changes in its facilities, equipment, operations or procedures that could affect the operation of the equipment. If this happens the telephone company will provide advance notice in order for you to make necessary modification to maintain uninterrupted service.

Do not attempt to repair this equipment yourself. If trouble is experienced with this equipment, for repair or warranty information please contact 1-800-574-1611

If the equipment is causing harm to the telephone network, the telephone company may request that you disconnect the equipment until the problem is resolved.

Signaling method: The unit's push-key dial allows it to signal in tones (DTMF). It can complete calls to local and long distance lines and can also complete long distance calls via

computer-phone systems such as MCI or SPRINT.

Ringer Equivalence Number: The FCC Registration label (on bottom of phone), includes a Ringer Equivalence Number (REN), which is used to determine the number of devices you may connect to your phone line. A high total REN may prevent phones from ringing in response to an incoming call and may make placing calls difficult. In most areas, a total REN of 5 should permit normal phone operation. To determine the total REN allowed on your telephone line, consult your local telephone company.

Hearing aids: The telephone is compatible with hearing aids equipped with an appropriate telecoil option and is compliant with the requirements for hearing aid compatibility of the Americans with Disabilities Act (ADA).

Programming emergency numbers: When programming emergency numbers and/or making test calls to emergency numbers:

1. Check with local authorities before making any test calls to emergency numbers.
2. Remain on the line and briefly explain to the dispatcher the reason for calling before hanging up.
3. Perform such activities in the off-peak hours, such as early mornings or late evenings.

CSA-NRTL/C installation instructions

Warning: Avoid electrical shock hazard to personnel or equipment damage observe the following precautions when installing telephone equipment:

1. Never install telephone wiring during a lightning storm.
2. Never install telephone jacks in wet locations unless the jack is specifically designed for wet locations.
3. Never touch uninsulated telephone wires or terminals unless the telephone line has been disconnected at the network interface.
4. Use caution when installing or modifying telephone lines.

Important safety instructions

When using your telephone equipment, basic safety precautions should always be followed to reduce risk of fire, electric shock and injury to persons, including the following:

1. Read and understand all instructions.
2. Follow the warnings and instructions marked on the product.
3. Unplug this product from the wall outlet before cleaning. Do not use liquid cleaners or

aerosol cleaners. Use a damp cloth for cleaning.

4. Do not use this product near water, for example, near a bath tub, wash bowl, kitchen sink, or laundry tub, in a wet basement, or near a swimming pool.

5. Do not place this product on an unstable cart, stand or table. The product may fall, causing serious damage to the product.

6. This product should never be placed near or over a radiator or heat register. This product should not be placed in a built-in installation unless proper ventilation is provided.

7. Do not allow anything to rest on the power cord. Do not locate this product where the cord will be abused by persons walking on it.

8. Do not overload wall outlets and extension cords as this can result in the risk of fire or electric shock.

9. Never spill liquid of any kind on the product.

10. To reduce the risk of electric shock do not disassemble this product, but have it sent to a qualified service person when some service or repair work is required.

11. Unplug this product from the wall outlet and refer servicing to qualified service personnel under the following conditions:

(A) When the power supply cord or plug is damaged or frayed.

(B) If the product has been exposed to rain, water or liquid has been spilled on the product, disconnect and allow the product to dry out to see if it still operates; but do not open up the product.

(C) If the product housing has been damaged.

(D) If the product exhibits a distinct change in performance.

12. Avoid using a telephone during an electrical storm. There may be a remote risk of electric shock from lightning.

13. Do not use the telephone to report a gas leak in the vicinity of the leak.

14. **CAUTION:** To eliminate the possibility of accidental damage to cords, plugs, jacks, and the telephone, do not use sharp instruments during the assembly procedures.

15. **WARNING:** Do not insert the plug at the free end of the handset cord directly into a wall or baseboard jack. Such misuse can result in unsafe sound levels or possible damage to the handset.

16. Save these instructions.



The exclamation point within an equilateral triangle is intended to alert the user to the presence of important operating and maintenance (servicing) instruction in the literature accompanying the product..

This symbol on the product is used to identify the following important information:

Shock Hazard Warning:

To avoid potential electrical shock hazard to personnel or damage to the telephone, use only the manufacturer supplied equipment and installation procedures. Specifically, use only 6 conductor modular Teladapt plug/cords with this product, and the AC transformer must be CSA/UL or CSA-NRTL/C approved Class 2, level C, rated as follows:

For North American Markets mains nominal AC voltage 110-117V:

For Venture EFA- Input: 117/120VAC, 50/60Hz, 12W and Output: 16VAC 500 mA.

For International Markets mains nominal AC voltage 220-240V:

For Venture EFA- Input: 220/240VAC, 50/60Hz, 12W and Output: 16VAC 500 mA.

Substitution of non approved equipment will void the Aastra warranty.

Warranty and repair

If you have several telephones and you are having problems with all of them, or if your telephone works in some outlets and not in others, your problem may originate with the local telephone lines or with central office equipment. Contact your telephone company repair service listed in the front of your phone book.

Should the terminal fail during the twelve month warranty period, please return it for repair to the manufacturer, or to the authorized agent as specified in the product literature. You will be responsible for shipping charges, if any, and for presenting proof of your telephone's date of purchase.

If the terminal is covered by a Telephone Company Maintenance Agreement, follow the procedure set forth in the Maintenance Agreement for obtaining repair or replacement of the terminal.

If the terminal is no longer covered by the manufacturer or its authorized agents' Warranty, and is not covered by a Telephone Company Maintenance Agreement, you may return the terminal to the manufacturer or its authorized agents for repair or refurbishment. You will be billed for any repairs.

Repair to this equipment can only be made by Aastra Telecom Inc. and its authorized agents, and by others who may be authorized by the FCC. Questions about the warranty or requests for the manufacturer's policy and procedure on repair and refurbishment should be directed to the manufacturer or authorized agent as specified in the product literature.

Manufacturer's limited twelve month warranty

Coverage: The manufacturer warrants this terminal against defects and malfunctions for a period of twelve months from the date of original purchase. If there is a defect or malfunction, Aastra Telecom Inc. or its authorized agents will, at its option, and as the exclusive remedy, either repair or replace the terminal at no charge if returned within the warranty period.

If replacement parts are used during repair, these parts may be refurbished or may contain refurbished materials. If it is necessary to replace the terminal, it may be replaced with a refurbished terminal of the same design and color. If it should become necessary to repair or replace a defective or malfunctioning terminal set under this warranty, the provisions of this warranty shall apply to the repaired or replaced terminal until the expiration of ninety (90) days from the date of pick-up, or the date of shipment to you of the repaired or

replacement set or until the end of the original twelve month warranty period whichever is later.

Exclusions: Aastra Telecom Inc. does not warranty this terminal to be compatible with the equipment of any particular telephone company. This warranty does not extend to damage to product resulting from improper installation or operation, alteration, neglect, abuse, misuse, fire or natural causes such as storms or floods after the terminal is in your possession.

Aastra Telecom shall not be liable for any incidental or consequential damages, including but not limited to loss, damage, or expense directly or indirectly arising from the customer's use or inability to use this product, either separately or in combination with other equipment. This paragraph, however, shall not apply to consequential damages for injury to the person in the case of telephones used or bought for use primarily for personal, family, or household purposes.

The warranty sets forth the entire liability and obligations of Aastra Telecom Inc. and its authorized agents with respect to breach of warranty, and the warranties set forth or limited herein are the sole warranties and are in lieu of all other warranties, expressed or implied, including warranties or fitness for particular purpose and merchantability.

State law provisions: This warranty gives you specific legal rights and you may have other rights which vary from state to state. Some states do not allow the exclusion of incidental or consequential damages or allow limitation on implied warranties or their duration, so that above exclusions or limitations may not apply.

A

account code
 using 13

activating

 background music 6
 CDR 10
 Door Phone 7
 Fax switch 9
 loudspeaker paging 6
 music on hold 5

adding

 Call Detail Recording 9
 electronic door latch 8
 fax machine or modem 8
 loudspeaker paging 6
 music source 5

answering a door phone call 12

B

background music 6
 at each Venture phone 12

C

Call Detail Recording

 activating CDR 10

 adding 9

 connecting a printer 10

Canadian regulatory

 information 19

CDR (see Call Detail
 Recording) 10

CDR printer location 9

connecting

 computer 10

 EFA to your system 4

 electronic door latch 8

 fax machine or modem 8

 loudspeaker page amplifier
 6

 music source 5

D

Distinctive Ringing 8

Door phone 7

E

EFA connection requirements
 17

EFA options not in Services
 list 14

EFA ports 3

electronic door latch 8

F

fax machine

 connecting 9

Fax switch

 activating 9

H

home run 15

M

modem

 connecting 9

music at idle 5

music on hold 5

P

password protecting

 EFA option settings 11

peripheral device wiring 1

ports, connections 3

printers, compatible 10

R

regulatory information

Canadian 19

U.S. 20

running cable to the jacks 15

S

saving to a memory key

Account code 13

Background music 13

Door phone 13

setting

Door phone options 7

T

Troubleshooting 14

twisted-pair cable 15

U

U.S. regulatory information 20

unpacking the EFA 2

using

account code 13

EFA functions 11

V

Venture Door Phone 6

connecting 7